



DesignLights Consortium™
Qualified Luminaire:
ST35QA1X279[U HJ5KC***
ST35QB1X279[U HJ5KC***
ST35QD1X279[U HJ5KC***

FEATURES

Heavy-Duty Low Profile Die Cast Housing with Integral Heat Sinking, Driver Compartment. Powdercoat Finish Over a Chromate Conversion Coating. Includes Twist Lock Photocell Receptacle.

Tempered Clear Flat Glass Lens or Tempered Clear Flat Prismatic Glass Lens.

2 $\frac{3}{8}$ " Diameter Mounting Arm, Adjustable Slipfitter, or Two-Piece Swivel Bracket.

Custom Colors Available Upon Request.

Listing & Ratings: CSA: Listed for Wet Locations, ANSI/UL 1598, 8750
IP66 Sealed LED Compartment.

LumaFit LED:

Delivered Lumens: 26,000 to 35,500

CRI: 86; CCT: 4000K, 5000K

Rated Life: 50,000 Hours; Aluminum Boards

Wattage: Array: 278.8w, System: 301.3w

Driver: Electronic Driver, 120-277V, 50/60Hz or 347-480V, 50/60Hz; Less Than 20% THD and PF>0.90. Standard Internal Surge Protection 6kV. 0-10V Dimming Standard for a Dimming Range of 100% to 10%; Dimming Source Current is 150 Microamps.

Controls: Fixtures Ordered with Factory-Installed Photocell or Motion Sensor Controls are Internally Wired for Switching and/or 1-10V Dimming Within the Housing. Remote Direct Wired Interface of 1-10V Dimming is Not Implied and May Not Be Available, Please Consult Factory. Fixtures are Tested with DuraGuard Controls and May Not Function Properly With Controls Supplied By Others. Fixtures are NOT Designed for Use with Line Voltage Dimmers.

Warranty: 5-Year Warranty for -40°C to +50°C Environment.

Options: Surge Protection

Accessories Sold Separately.

ORDER INFORMATION

DuraLED Large Hampton Area/Roadway

Catalog #

Description

Complete Units

Ordering Information

Example: ST35QF1X279U5KCZMAP40

ST35	Model:	ST35
Q	LED Mfr:	Q=QSSI
F	Optics:	A=Type I, B=Type II, C=Type III, D=Type IV, F=Type V
1X	Number of Arrays:	1X=One
279	Wattage:	279=279w
U	Ballast:	U=120-277V, H=347-480V
5K	CCT:	4K=4000K, 5K=5000K
C	Lens:	C=Tempered Clear Flat Glass Lens, P=Tempered Clear Flat Prismatic Glass Lens* *Use with F Optic Only.
Z	Color:	Z=Bronze
MA	Mounting:	BR=Two-Piece Swivel Bracket, SF=Slipfitter, MA=Mounting Arm Adapter
P40	Options:	Specify Twist Lock Photocell: P40=P18140 110-120VAC Instant, P42=P18142 105- 287VAC Instant, P50=P18150 120VAC Time Delay, P52=P18152 277VAC Time Delay, P56=120-277VAC Universal R3=3-Pin Twist Lock Photocell Receptacle, R7=7-Pin ANSI C136.41-2013 Twist Lock Receptacle, SF=Single Fuse, DF=Double Fuse, SP=Surge Protection

DuraLED Large Hampton Area/ Roadway



ST35

DIMENSIONS

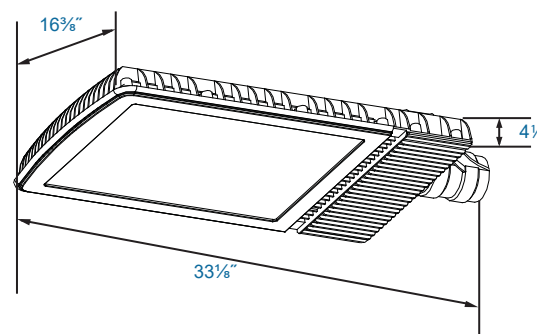

ST35

APPLICATIONS

Shipping and Receiving Areas
Industrial Plants
Commercial Buildings
Road Way Applications

LED

ACCESSORIES

ST35GLP - Prismatic Flat Glass Lens
ST35GSZ - Aluminum House Side Shield, Bronze Powdercoat Finish, Includes Hardware.
ST35WG - Wire Guard, Stainless Steel Construction.
STSFZ - Adjustable Die Cast Double Slipfitter with Angle Indicators Allows Mounting on Vertical Tenons, Includes Hardware. Bronze Finish.
CVMAZ - Mounting Arm Adaptor, Fits 2 3/8" Arm, Includes Hardware, Bronze Finish
POLEACC030 - 4" 180° Twin Square Horizontal Tenon, Bronze Finish
POLEACC030AZ - 5" 180° Twin Square Horizontal Tenon, Bronze Finish

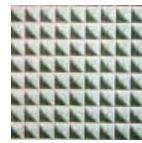

ST35GLP



ST35GSZ

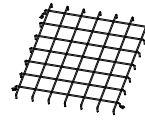

ST35WG



STSFZ
(Shown Mounted)



CVMAZ
(Shown Mounted)



Swivel Bracket
(SSBZ)



Slipfitter
(SSFZ)



POLEACC030Z,
POLEACC030AZ



Single Pole Tenon
Spoke Bracket
(PTSB1SZ)



90° Twin Pole Tenon
Spoke Bracket
(PTSB290SZ)

PHOTOCELLS:

P18130 - 480VAC Twist Lock Photocell Receptacle
P18130R7 - 7-Pin Twist Lock Photocell Receptacle ANSI C136.41-2013 with Integrated Controls for LED, 480 VAC
P18131 - Twist Lock Non Shorting (Open) Cap disconnects service to fixture for temporary or permanent disabling (fixture always off). IP65, 480V maximum.
P18132 - Twist Lock Shorting Cap provides fixed service to fixture (fixture always on). IP65, rated load 7200w Tungsten.
P18140 - 110-120VAC Instant Twist Lock
P18142 - 105-287VAC Instant Twist Lock
P18150 - 120VAC Time Delay Twist Lock
P18152 - 277VAC Time Delay Twist Lock
P18154 - 480VAC Time Delay Twist Lock Photocell. For 480V use only.
P18156 - 120-277VAC Universal Twist Lock Photocell



180° Twin Pole
Tenon Spoke Bracket
(PTSB180SZ)



90° Triple Pole
Tenon Spoke Bracket
(PTSB390SZ)



180° Triple Pole
Tenon Spoke Bracket
(PTSB180SZ)



90° Quad Pole Tenon
Spoke Bracket
(PTSB490SZ)



P18130

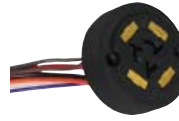

P18130R7



P18131



P18132



P18140,
P18142



P18150,
P18152



P18154



P18156

**Non-stock item. Consult factory for lead time.*

PHOTOMETRICS

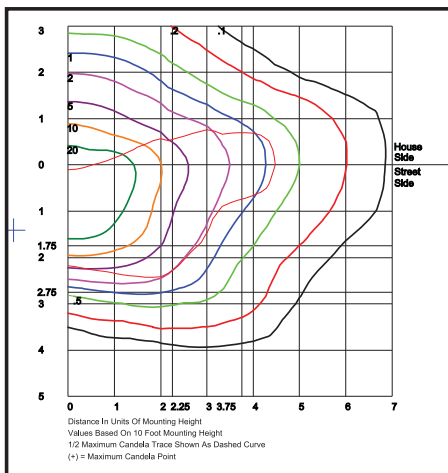

ST35QC1X279U5KC

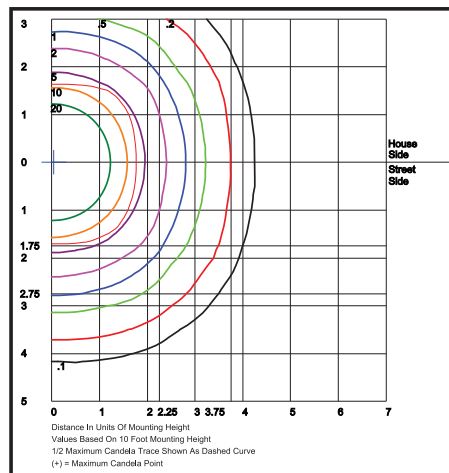

ST35QF1X279U5KC

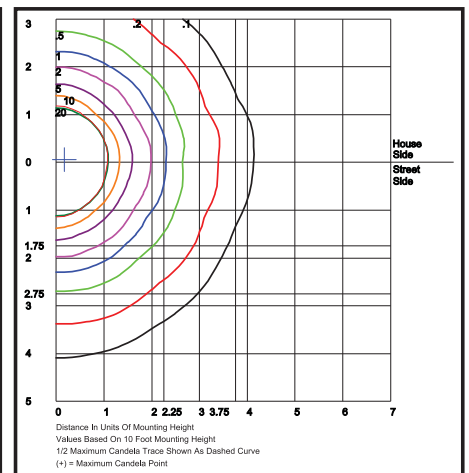

ST35QF1X279U5KP

Specifications subject to change without notice.